

DOMUSA

T E K N I K

The most advanced technology
at the most reasonable price

BIOMASS BOILERS

BIOCLASS DX

FOR HEATING AND DHW PRODUCTION

- > "ICONNECT" APP CONNECTIVITY
- > HEATING AND DHW PRODUCTION
- > FULLY EQUIPPED
- > AUTOMATIC CLEANING SYSTEM
- > "FLAME LOGIC" COMBUSTION CONTROL
- > INTEGRATED STAINLESS STEEL CYLINDER
- > TWO SIZES: 18 and 25 kW



NEW PELLET BOILER FOR HEATING AND DOMESTIC HOT WATER PRODUCTION

BIOCLASS DX

A new concept in comfort and equipment using a biomass heating system

The ideal solution for energy transition to renewable fuels.

Domestic hot water through accumulation, a buffer tank and a hopper, all in one compact piece of equipment.



iConnect CONNECTIVITY

The BIOCLASS IC DX product range is equipped with standard connectivity so the user can control the boiler and other installation components through the iConnect app, provided a WiFi network is available at the boiler installation site, with the following features:

- Starting up and shutting down the equipment.
- Choosing hot water and heating temperature set.
- Accessing information on use over time (consumption, ash pan filling status, etc.).
- Receiving alerts and suggestions.
- Programming equipment operating times, etc.



FLAME LOGIC

BIOCLASS IC boilers come with the "FLAME LOGIC" intelligent combustion control system, which constantly analyses flame quality and air flow to achieve optimal combustion of the biomass pellets.



HIGH DHW PRODUCTION WITH A STAINLESS STEEL ACCUMULATOR

The BIOCLASS IC DX range of boilers ensures high production of domestic hot water and fast temperature recovery in the accumulator for subsequent use.

It includes a stainless steel accumulator and compact inertia buffer tanks that requires less space for installation.



TRANSITION TO RENEWABLE ENERGY
with all the features and a compact design



SAVINGS

The design of the BIOCLASS IC DX boiler ensures that the combustion gases yield the maximum energy to the heating fluid, thereby significantly reducing the temperature of the gases. This type of boiler, known as a low temperature boiler, achieves high energy performance and reduction in fuel consumption, compared to conventional boilers.

Another important feature is its electronic power modulation, a system that can adjust combustion energy to the heating requirements of the home at any time, ideal to adapt to temperature needs at different times of the year. This avoids undesired stops and starts and subsequent expense due to unnecessary fuel consumption.



COMFORT

This boiler is equipped with full automatic cleaning of both the fume pipe heat transfer system (via a system of cams powered by a motor) and the burner (via a mobile base). Therefore, users do not have to worry about periodic boiler cleaning, except the annual cleaning performed by an authorised technical service. Automatic cleaning is performed without having to shut down the boiler, so users never go without heating and domestic hot water.

The ash generated by combustion is collected in the ash pan, which will have to be emptied when required, depending on consumption. The ash emptying process can be extended by including a compressor ashtray (optional).



WARRANTY

The high quality of the materials used to manufacture the BIOCLASS boiler account for the 5-year warranty for the heat exchanger and 2-year warranty for the hydraulic and control components.



FULLY EQUIPPED

The BIOCLASS IC DX boiler comes fully equipped in a compact design.

Standard equipment includes a stainless steel DHW tank and integrated inertia buffer tank, a water flow pump, heating expansion vessel, DHW expansion tank and bleeders, among other components.

BIOCLASSIC IC DX boilers are also equipped with an innovative system to preheat return water. The HotStream system avoids the need for complicated mixing systems to prevent condensation caused by cold returns in the installation.

The reheating system can be used with direct returns to the boiler as high as 25°, thus allowing direct installation regardless of the type of hydraulic configuration of the installation.

There is also a wide range of optional hydraulic kits available to solve the most diverse home installation needs. All these kits are fitted with a regulating system that controls the flow temperature according to the exterior temperature, thereby optimising installation consumption. Among the various configurations that can be set up with these kits are underfloor heating systems for two areas with different flow temperatures.



HYDRAULIC KITS

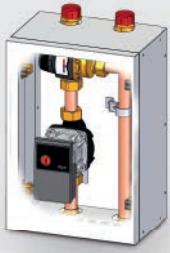

Hydraulic kit
Mt

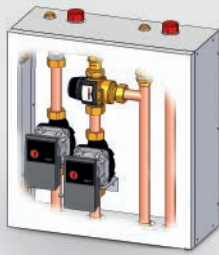

Hydraulic kit
DMt

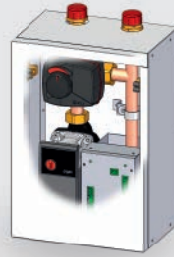

Hydraulic kit
BIO M

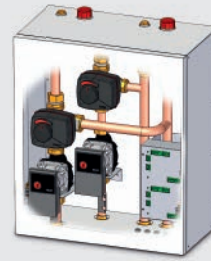

Hydraulic kit
BIO 2M

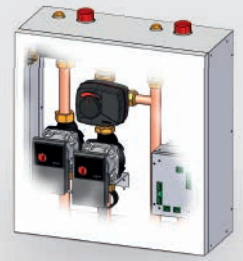

Hydraulic kit
BIO DM/MS

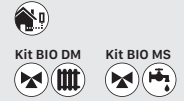

COMPRESSOR ASHTRAY

The boiler can be equipped with a compressor ashtray to reduce the frequency of ash pan cleaning. This ashtray features an ash compression system that reduces the frequency of ash pan maintenance.

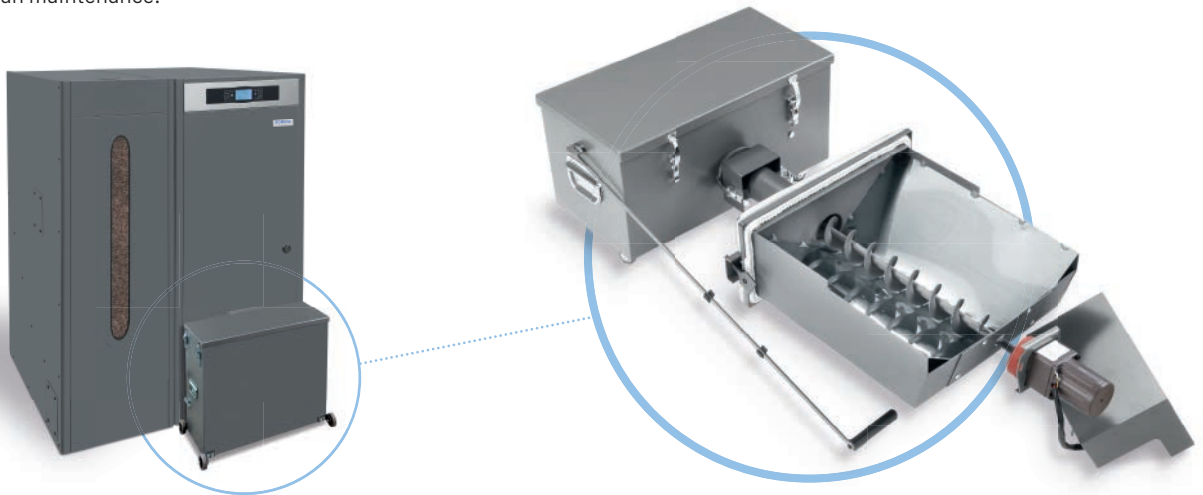

SILO

A wide range of fabric silos are available for use with the CVS suction system.

Silo assembly is fast and easy and does not require screws or specific tools; it only takes 30 minutes and an Allen wrench. Silo aesthetics and robustness are enhanced by a galvanised steel structure consisting of cast parts, set screws and additional fasteners. It is made of high-strength technical fabric that discharges static

electricity directly to the ground connection of the building or boiler. The fabric allows the material to ventilate but does not release dust, so two storz fittings are not needed in the filling systems.

Made of high-strength fabric with seam protection and free of condensation caused by temperature fluctuations.

It can be installed outdoors, provided it is protected against the rain and direct sunshine.

Model	Capacity*		Dimensions		
	Tm	Surface area m ²	Height m	Volume m ³	
Silo 2.0	1.8-2.5	1.45 x 1.45	2 / 2.5	3.2 - 3.8	
Silo 3.0	2.2-3.0	1.75 x 1.75	2 / 2.5	3.8 - 4.7	
Silo 4.0	3.0-4.1	2.05 x 2.05	2 / 2.5	5.1 - 6.4	
Silo 5.0	3.7-5.2	2.25 x 2.25	2 / 2.5	6.2 - 8.0	

* The capacity of the Fabric Silo will depend on the type, density and quality of the pellets used, as well as on the height of the installation site.

AUTOMATIC LOADING SYSTEM

PELLET LOADING SYSTEM FOR HOME MADE SILO AND AUGER

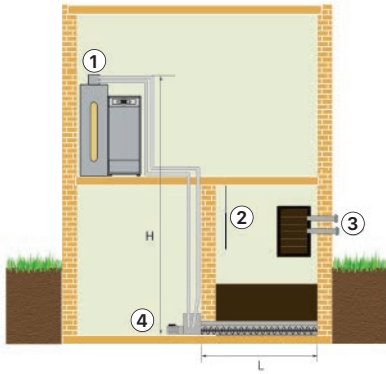

LOADING SYSTEM WITH A CANVAS SILO

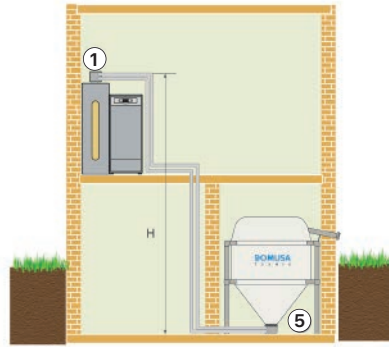

LOADING SYSTEM WITH A HOMEMADE SILO AND A FIXED VACUUM SYSTEM

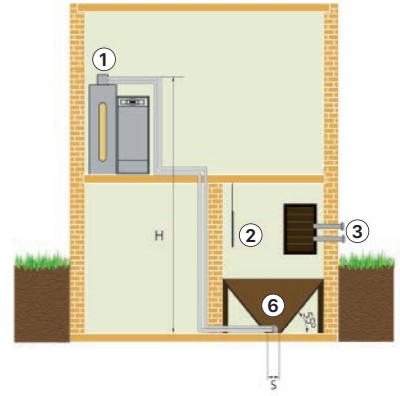

PELLET LOADING SYSTEM FOR HOME MADE SILO AND NOZZLE CHANGER KIT

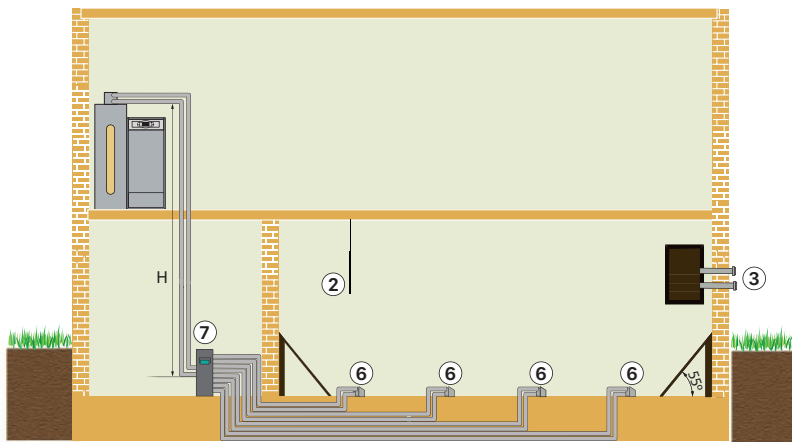

DESCRIPTION

- ① CVS vacuum unit
- ② Impact protection canvas
- ③ Storz filling connection pipe
- ④ Home made silo auger
- ⑤ Silo
- ⑥ Homemade silo suction nozzle
- ⑦ Automatic nozzle changer kit

MAX. HEIGHT	m	6
MAX. SURFACE AREA	m ²	1
MAX. LENGTH	m	25
MAX. LENGTH WORM GEAR	m	5

OPTIONS



Coupling kit for L hopper



Flexible hose

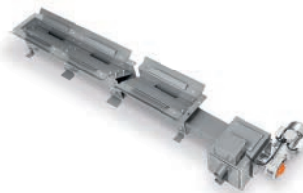

Homemade silo auger 1.5

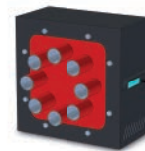

Automatic nozzle changer kit



Canvas silo vibrator kit

HOME MADE SILO EQUIPMENT



Storz filling connection pipe



Impact protection canvas

CVS vacuum unit



DIMENSIONS

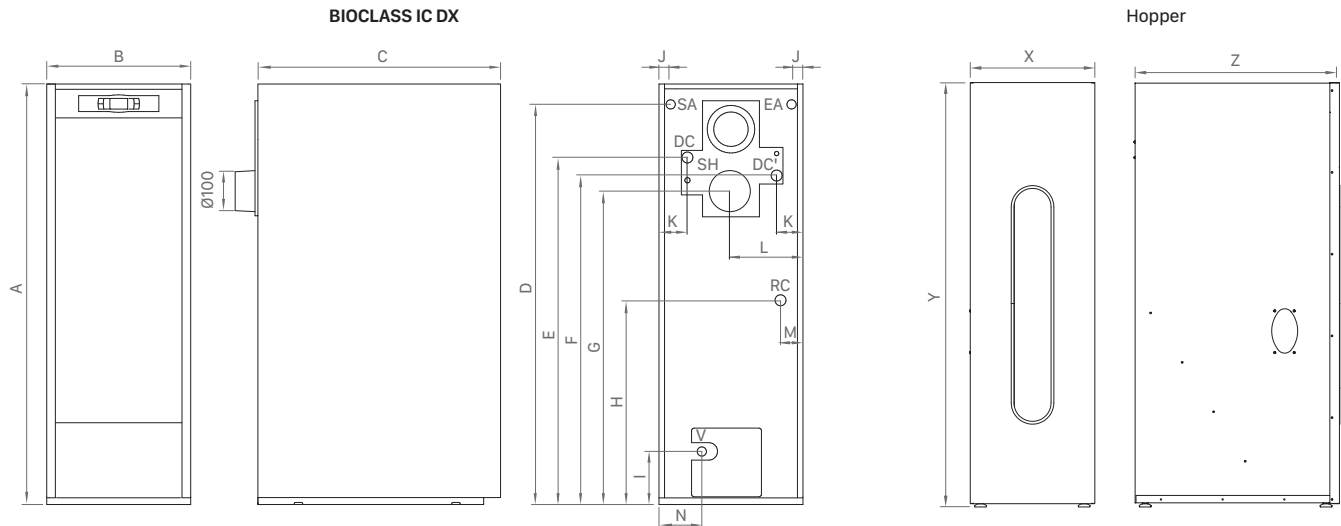

DC: Flow
DC': Optional flow
EA: DHW inlet
V: Drain valve
RC: Return
SH: Chimney connection
SA: DHW outlet

MODEL	A	B	C	D	E	F	G	H	I	J	K	L	M	N
BIOCCLASS IC DX 18	1,590	545	920	1,510	1,315	1,245	1,185	770	200	45	100	270	85	195
BIOCCLASS IC DX 25	1,590	670	1,020	1,510	1,315	1,245	1,185	770	200	45	100	335	95	210

MODEL	X	Y	Z
DX S hopper	404	1,590	920
DX L hopper	685	1,590	920

EQUIPMENT

BIOCCLASS IC DX EQUIPMENT	
1. Stainless steel cylinder	13. Ambient temperature probe
2. Buffer tank	14. Automatic bleeder
3. Circulation pump	15. Fan motor
4. Heating expansion vessel	16. Automatic fume pipe cleaning system
5. DHW expansion tank	17. Safety unit
6. Pressure limiter	18. Dielectric sleeves
7. Flame no-return system	19. DHW recirculation intake
8. Air pressure sensor	20. Drain valve
9. Ash pan	21. Safety valve
10. Burner	Sight glass
11. Feed worm gear	Filling grille
12. Filling loop	

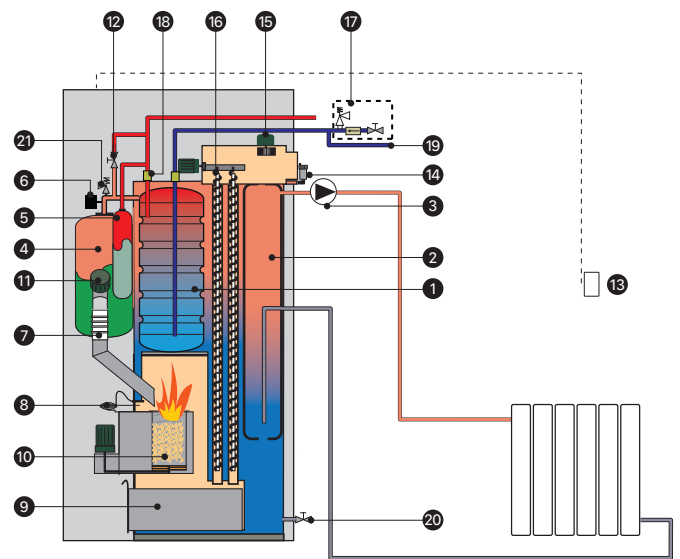

SPECIFICATIONS

MODEL	RATED POWER kW	RATED HEAT OUTPUT %	PARTIAL LOAD POWER kW	PARTIAL LOAD OUTPUT %	BOILER WATER VOLUME L	DHW PRODUCTION L/10 MIN Δ30°C	CONTINUOUS DHW PRODUCTION IN L/H Δ30°C	STAINLESS STEEL CYLINDER L	ENERGY EFFICIENCY CLASS
BIOCCLASS IC 18 DX	18	>92	5,4	>90	88	236	666	90	A+
BIOCCLASS IC 25 DX	25	>92	7,5	>90	104	319	830	120	

HOPPERS	FUEL CAPACITY IN kg
DX S HOPPER	240
DX L HOPPER	365



MAILING ADDRESS

Apdo. 95
20730 AZPEITIA
(Gipuzkoa) Spain

HEADQUARTERS & FACTORY

Bº San Esteban, s/n.
20737 ERREZIL (Gipuzkoa) Spain
Tel.: +34 943 813 899

WAREHOUSE

Atxubiaga, 13
Bº Landeta
20730 Azpeitia
(Gipuzkoa) Spain

domusateknik@domusateknik.com
www.domusateknik.com

